

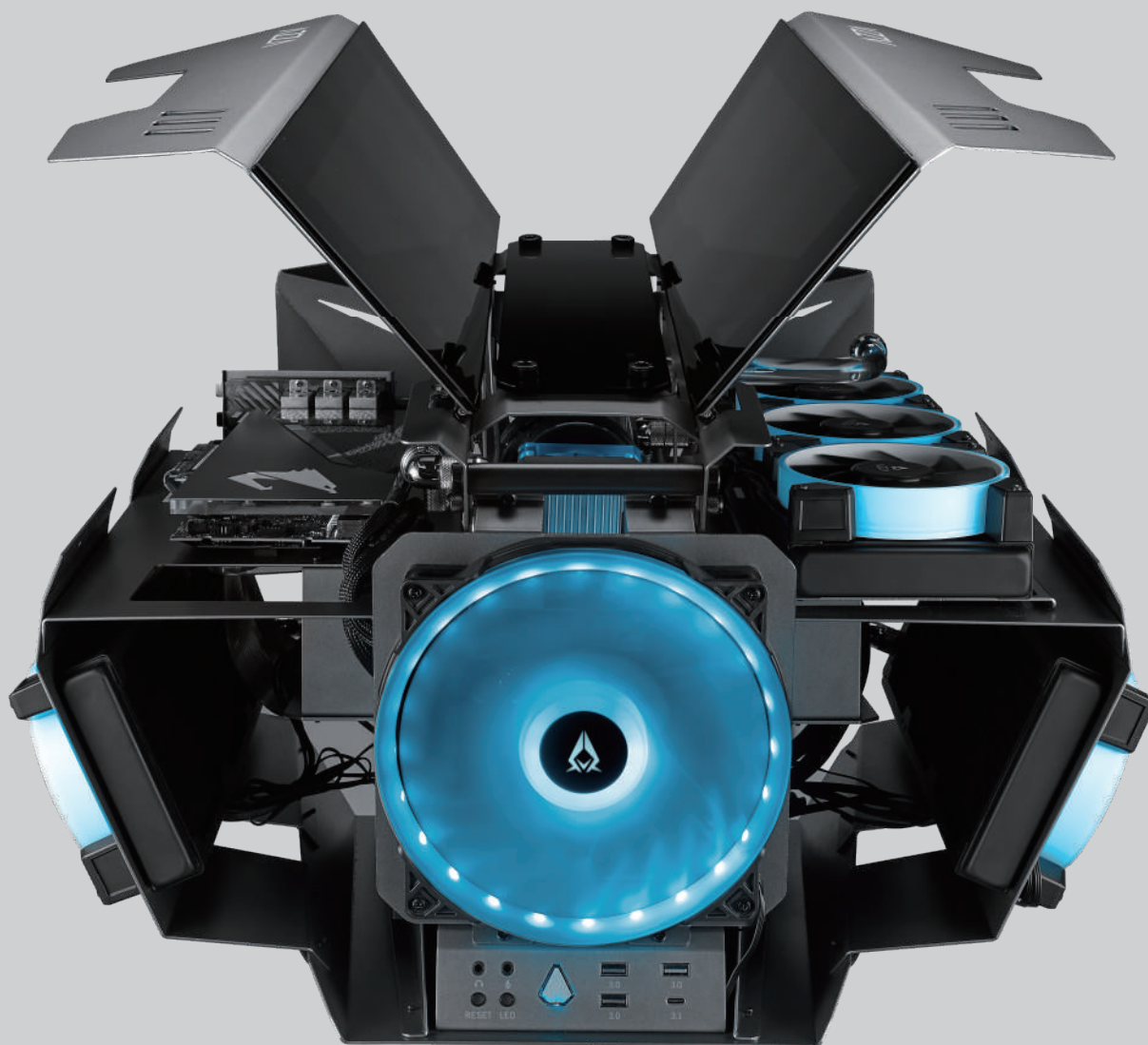

OVERDRIVE





Model	
Model Name:	OVERDRIVE
Name:	CSAZ-807
Specifications	
Type:	ATX Tower
Color:	1.5~2.0mm SPCC+ 2.5mm Aluminum
Top Panel:	Aluminum and tempered glass wing
Max CPU Cooler Height:	Up to 80mm
Max GPU Length:	Up to 400mm long Video card (Horizontal)
Max Cooling Tube Reservoir Length:	UP to 300mm
Power Supply:	ATX
Motherboard Compatibility:	<305x280mm E-ATX 、 ATX 、 Micro ATX 、 Mini ITX
Expansion	
External 5.25" Drive Bays:	0
Internal 2.5" Drive Bays:	Up to 2
Internal 3.5" Drive Bays:	Up to 2 (Convertible with 2.5"SSD x 2)
Expansion slots:	3+3
Front Ports:	3xUSB 3.0 、 HD Audio 、 Type C 、 Metal power button
Physical Specifications	
Metal Chassis Dimensions (HxWxD)	440x570x590mm/17.3x22.4x23.2 inch
Weight:	23kg /50.7lbs
Features	
Outer Appearance:	All external panels are made of aluminum with two glass top panel, gull-wing panel design makes it easy to adjust and clean on usually.
Available Fan Ports:	Front: 1 x 200mm fan port (1x 200mm Addressable RGB fan included) Top: 6 x 120mm/ 4 x 140mm fan ports Sides: 6 x 120mm fan ports
Water Cooling:	Top: Supports radiators up to 280/360mm x 2 Sides: Supports radiators up to 360mm x 2
Isolated Chamber:	ATX Power supply inside its own isolated chamber, preventing its heat from affecting other components
Easy Installation Cooler:	A pre-cut hole for easy installation of CPU Cooler, eliminating the need to remove the motherboard
Accessories	Radiator bracket x 2 - Support 280/360mm on top two sides. 300 mm PCI-e 3.0 Riser Cable Another 300mm PCI-e 4.0 extension cable version is available AZZA Hub (RGB+Fan Controller) x1 PCI-e Slot Brackets x2 Decorative Backplates x2

1. Front Panel Functionality :



Front Fan:
200mm Addressable RGB Fan included



Front I/O:
Reset / LED / Audio / Mic / USB3.0*3 / Type C

2. Motherboard Installation :

(1) Turn the screws counterclockwise to remove the glass.

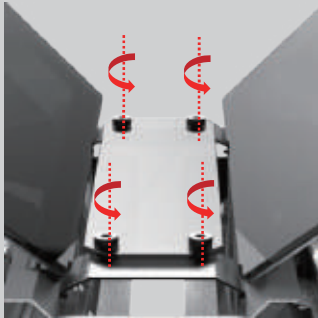

(2) Put the motherboard in from behind.

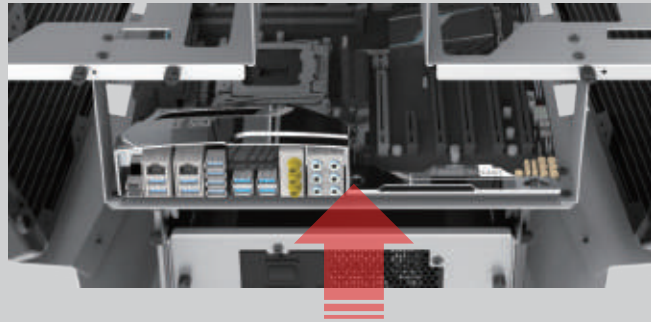

(3) Screw the motherboard onto the tray through the chassis.



3. Power Supply Installation :

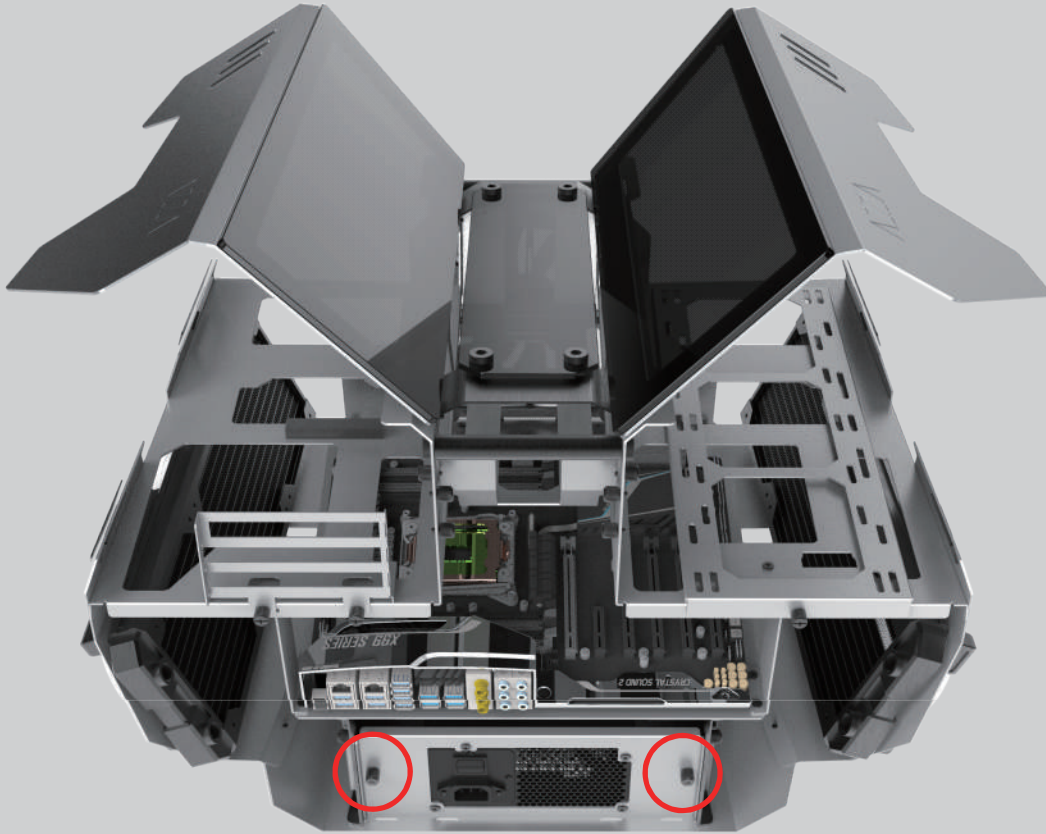

Loosen the hand screws to remove the power supply bracket. Attach the power supply to the bracket before placing it back in.

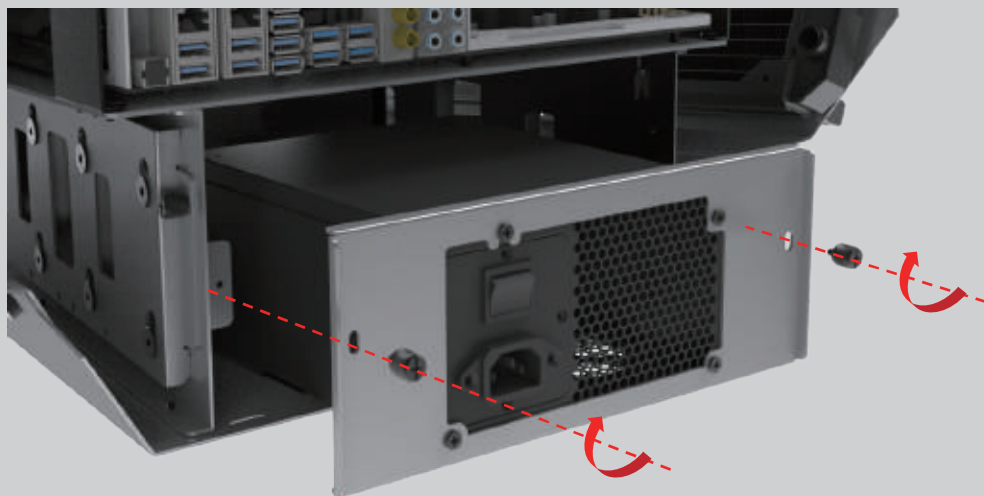

4. Fan & Radiator Installation :

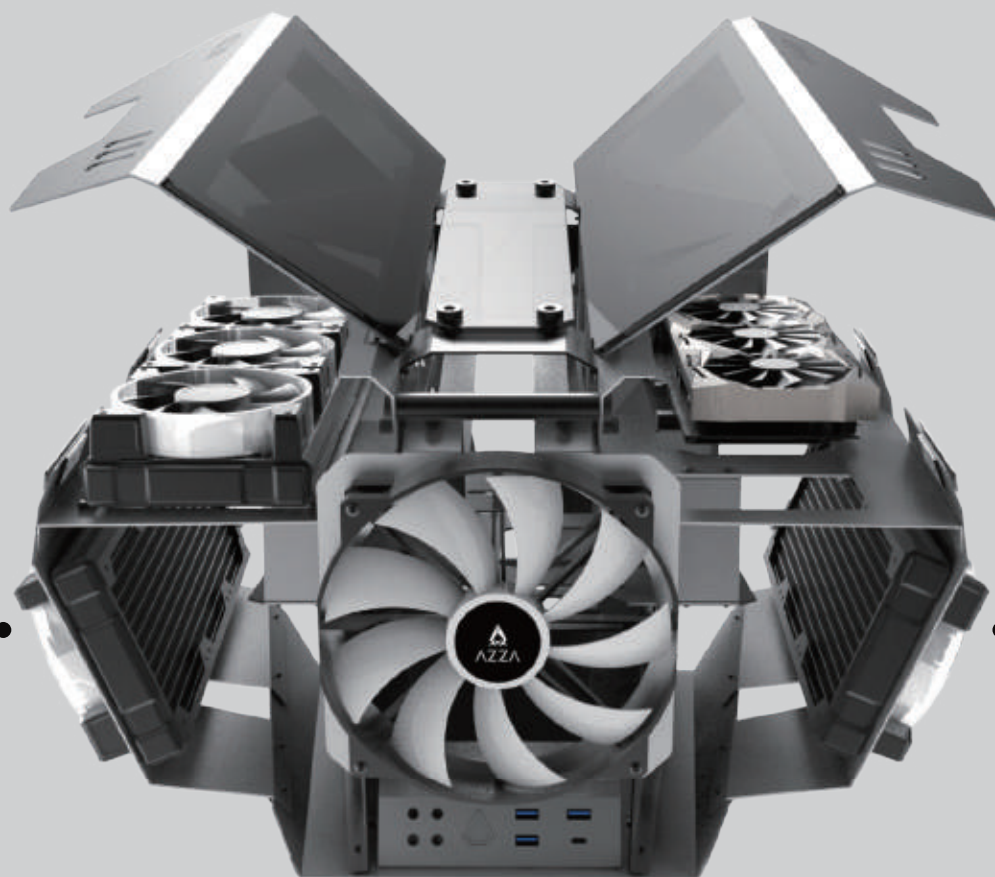

240 or 360 mm radiators
or 6*120 mm fans on the sides

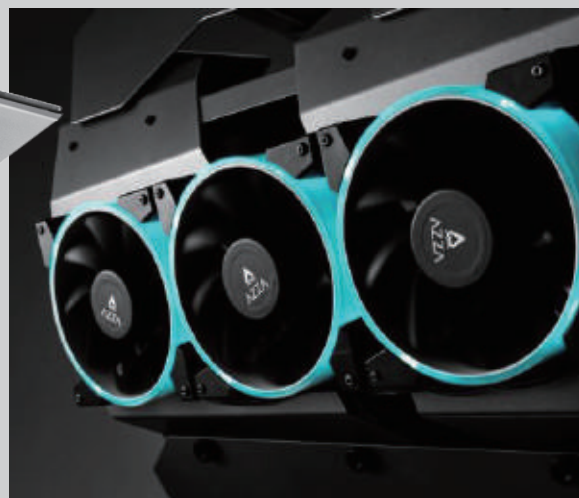
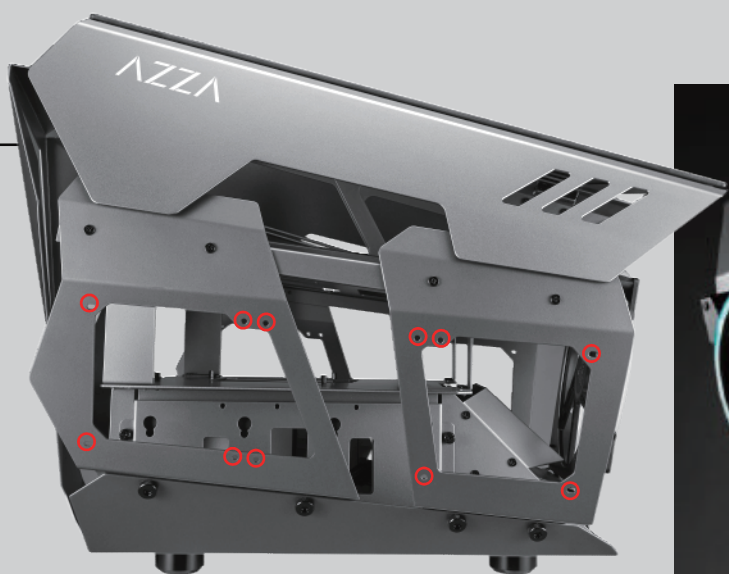

5. Fan & Radiator installation :

•When installing a radiator:
Use long screws to affix the fan and radiator onto the chassis as shown.

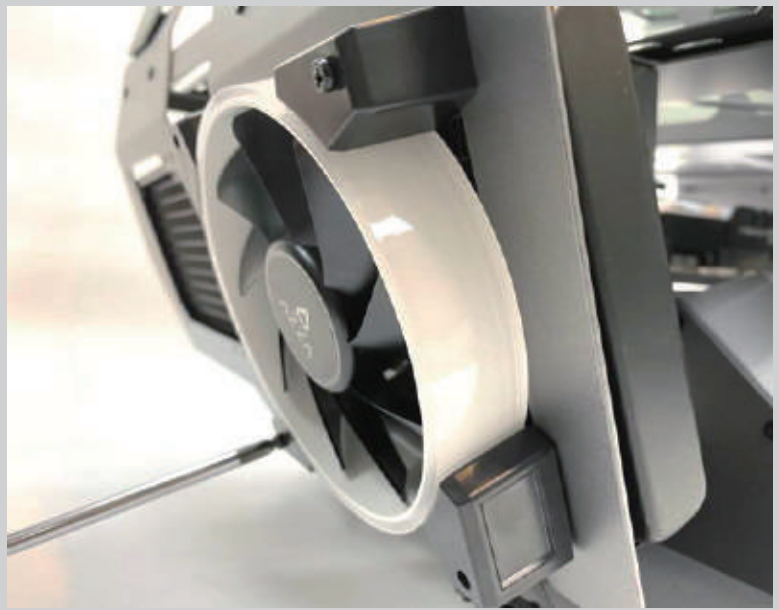

•When installing fans only:
Use nuts on the rear of the screw to affix the fan onto the chassis as shown.



6. Reservoir & Pump Installation :

Turn the handscrews
counterclockwise to remove

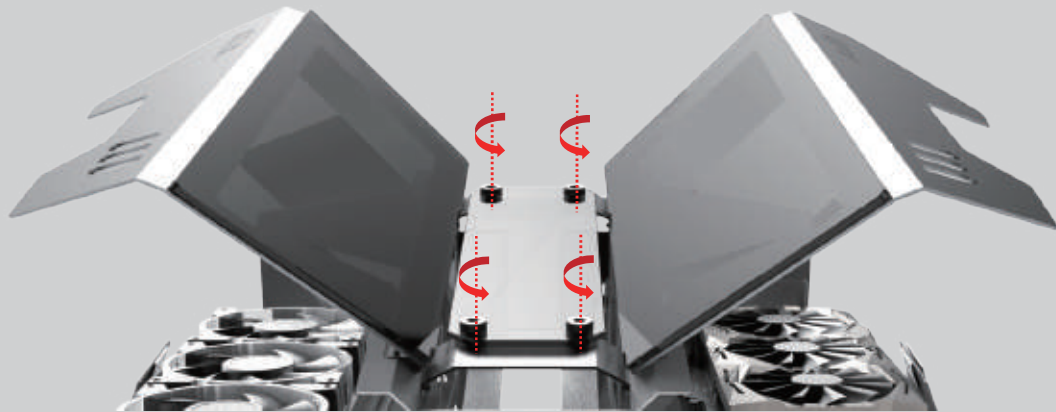

Install Reservoir and/or Pump

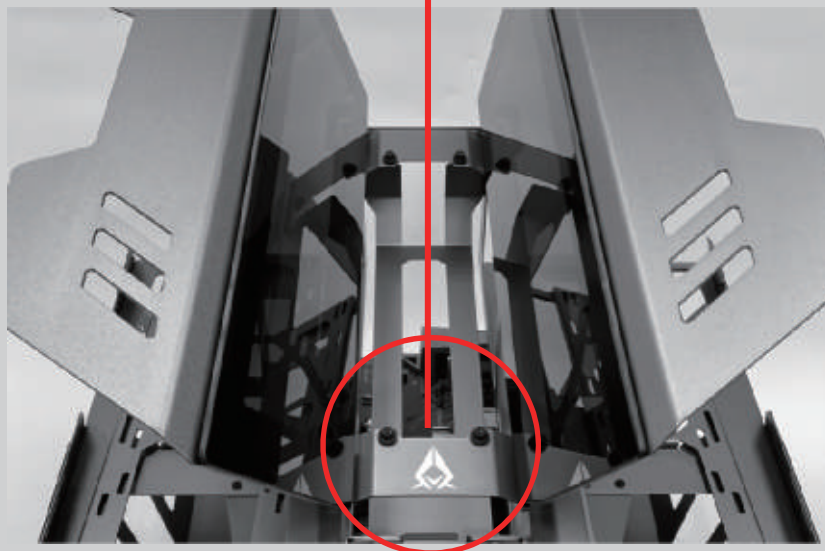
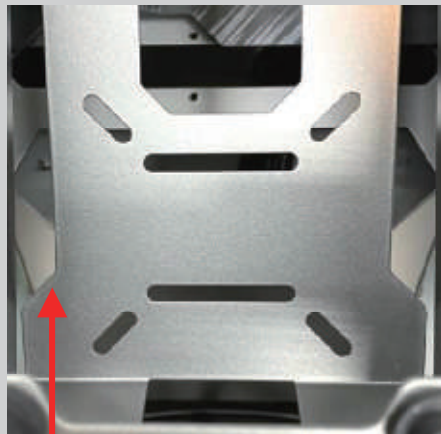

7. Graphics Card or Radiator Installation :

Supports up to 280 mm or 360 mm radiator

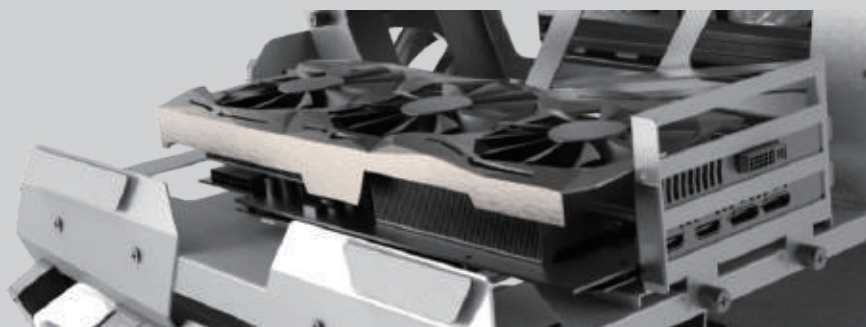
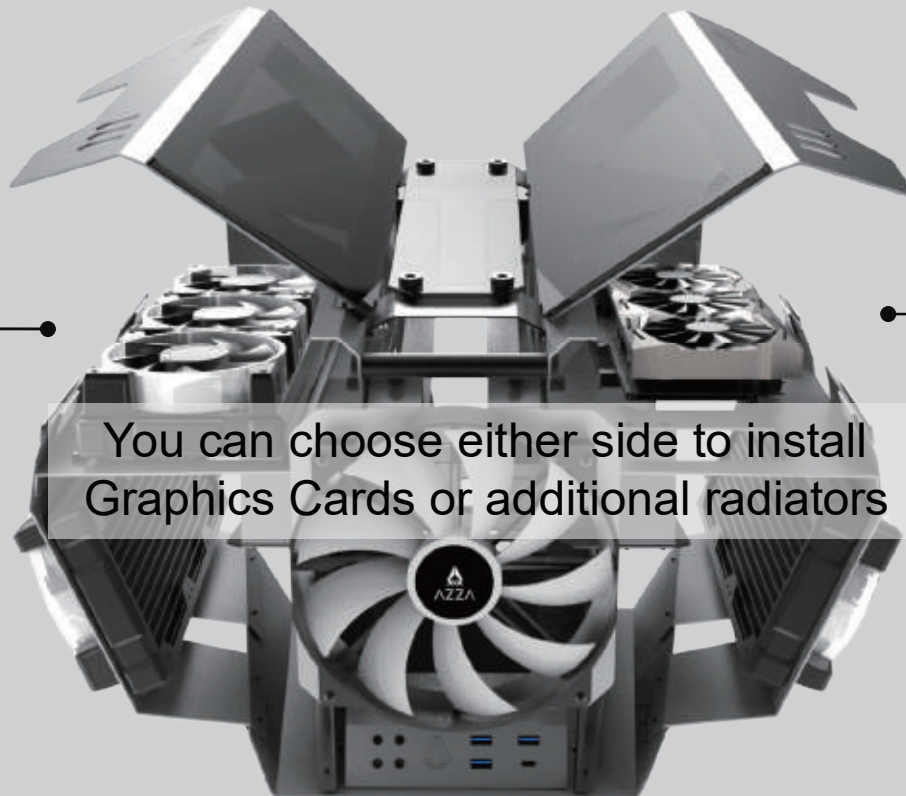
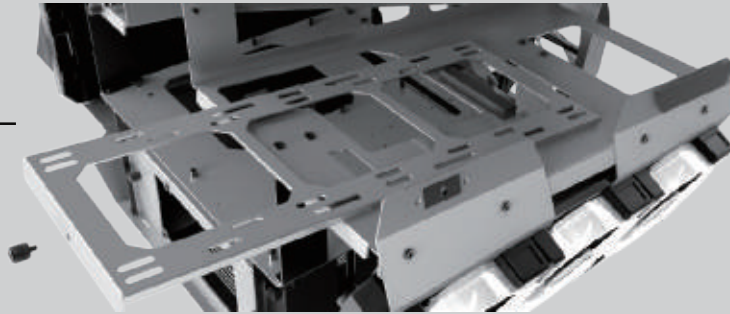

Graphics Card length up to 400 mm / 3 slots

8. Graphics Card Installation:

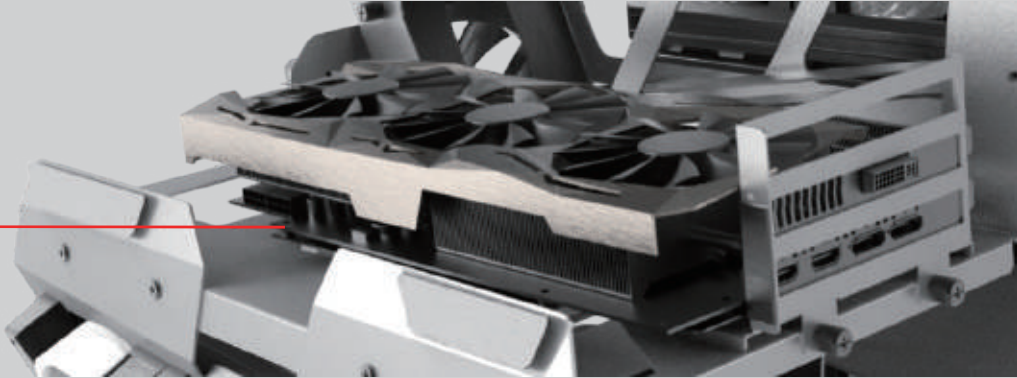

Attach the EVA foam supplied in the parts kit to support the graphics card

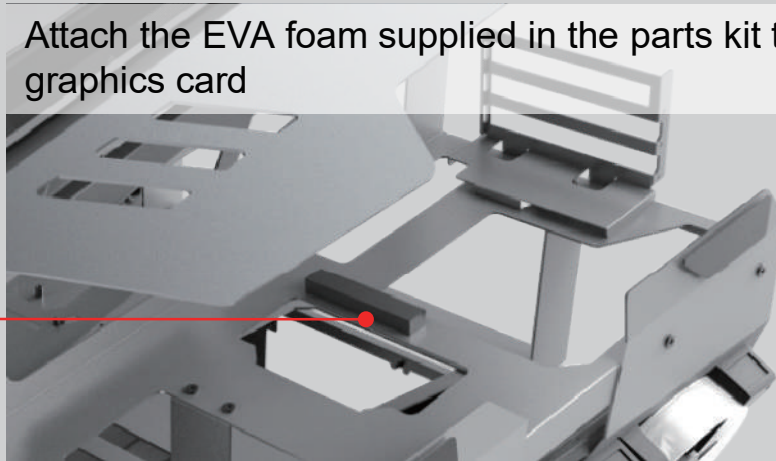

PCI-e cable installation: Plug the cable onto the motherboard by passing the cable through the hole as shown

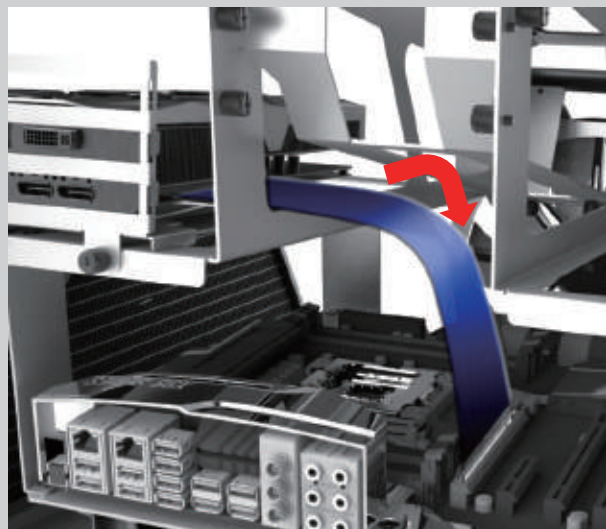
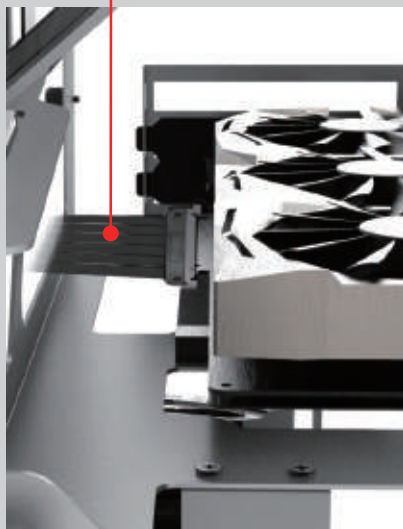

9. Storage Drive Installation :

(1) Remove the 2 handscrews.

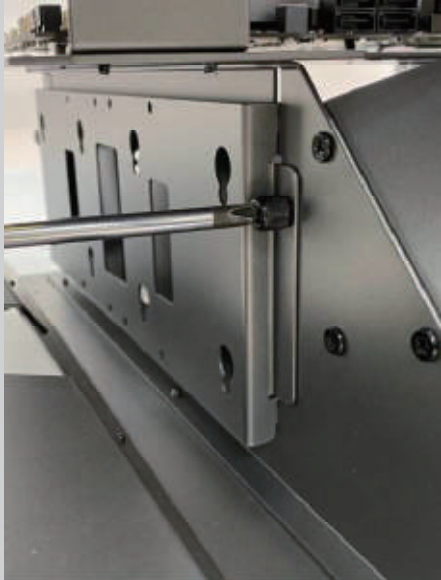

(2) Lift and pull away to remove.



Disk Drive Mounts on both sides:
Two 2.5" drives or one 3.5" drive

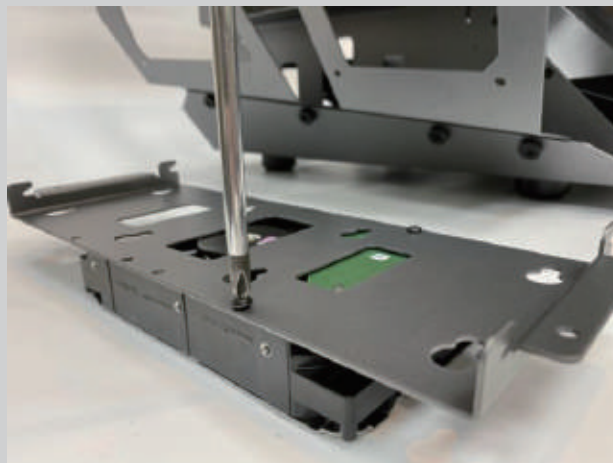
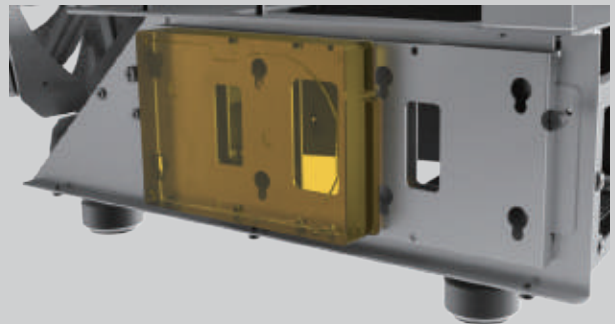
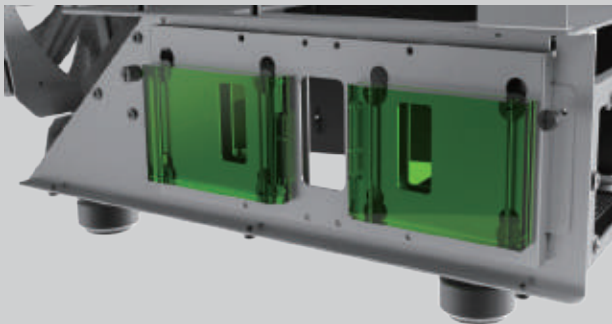

10. Rear Cover Installation :

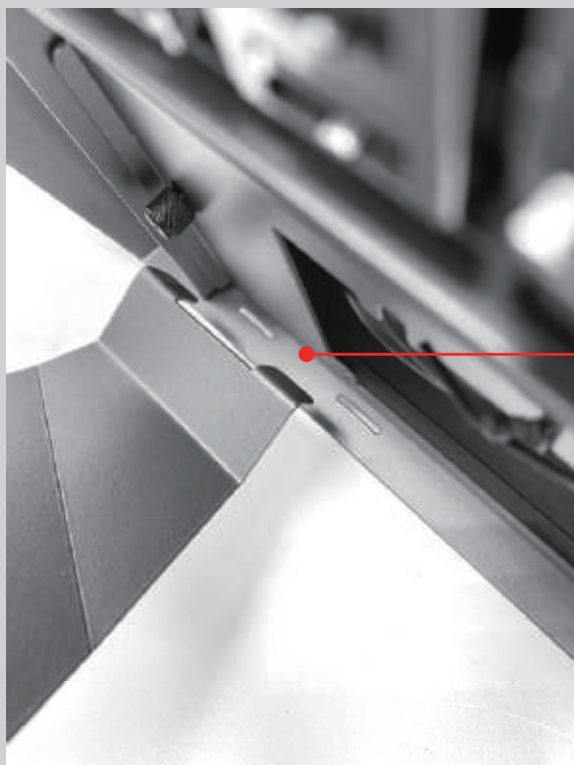

Slide into cut-out

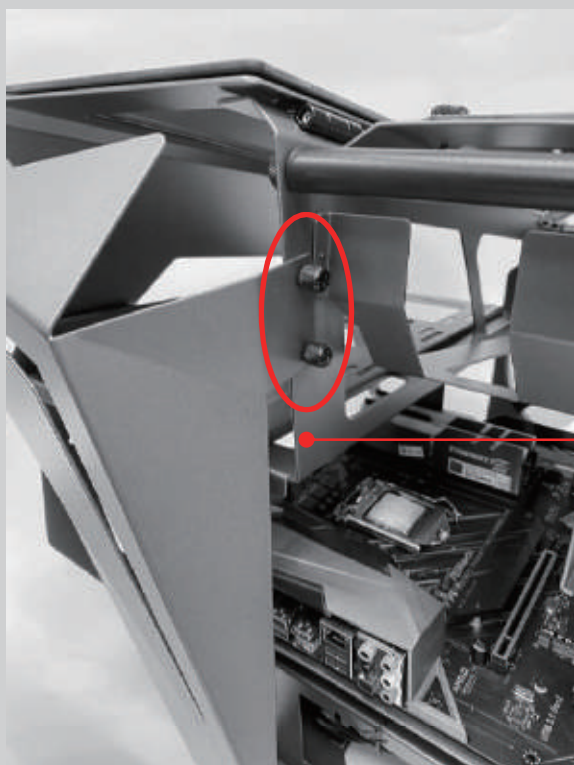
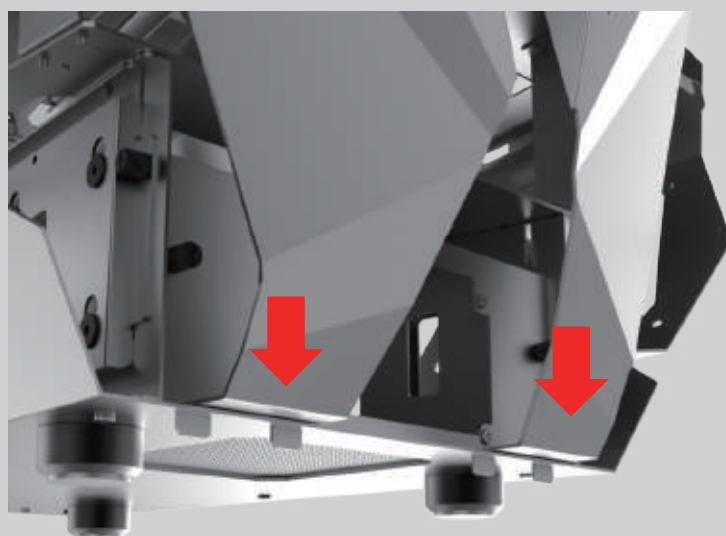

Screw to secure

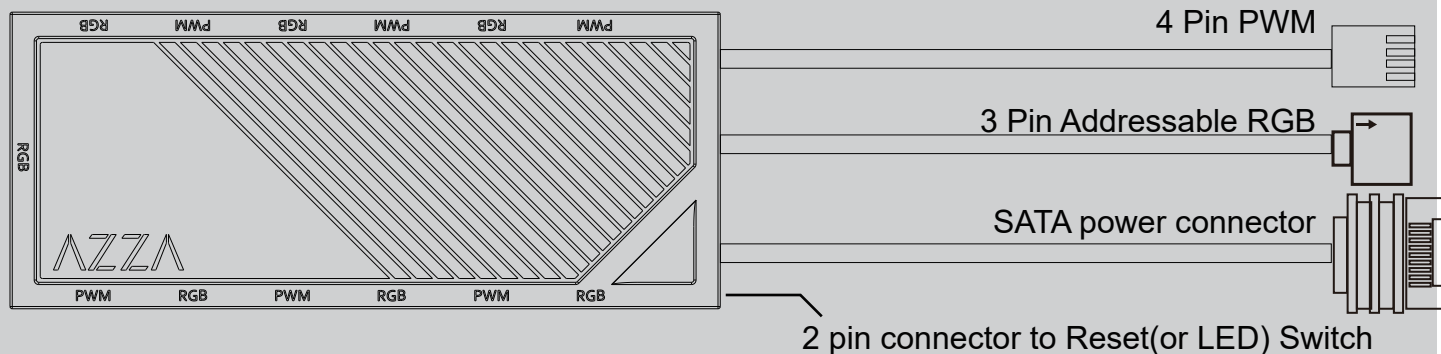

Ports and connectors

- 1.) 7x3 pin ARGB ports (supports ARGB devices: ARGB fan, ARGB strips...etc)
- 2.) 6x4 pin PWM fan ports
- 3.) 1x2 pin connector to Reset (or LED) switch
- 4.) 1xSATA power connector
- 5.) 1x3 pin ARGB connector to MB
- 6.) 1x4pin PWM fan connector to MB

Functions:

- 1.) Total of 17 lighting modes
 - 2.) Lighting modes can be controlled by Reset (or LED) switch, or can be controlled by MB.
(Hold the LED button for 3 seconds to switch the RGB control function between motherboard RGB software and LED button)
- A.) Magnet on the back of the hub box or using velcro on the back of the hub box, it can put in any place inside the metal part of the case.
- B.) 6 sets of ARGB port next to PWM port to ease the connection on fans



300 mm PCI-E 3.0 Cable(Support EATX 、 ATX Motherboard)
Another 300mm PCI-e 4.0 extension cable version is available

4.0 The latest 4.0 version provides faster transmission speed

- This extension cable supports the following graphics cards: RTX 3000 series, RTX 3080, RTX 3090 FE, RX 5700XT and RX 6000 GPUs.
- Please note before use:
 1. Measure the distance between your motherboard, PCI-E slot and GPU connection to confirm whether the length of this 4.0 cable is sufficient.
 2. Update your motherboard BIOS to the latest version.
 3. Update your GPU software to the latest version.
 4. Check whether the motherboard BIOS setting is 4.0. Some software will not switch automatically. If the switching fails, the PC will not start normally.



