

# Sanctum





Model	
Model Name	Sanctum
Model Number	CSAZ-810
Specifications	
Type	ATX
Chassis Thickness	SPCC 0.8-1.2 mm / AL 2mm
Max CPU Cooler Height	Up to 190mm
Max Video Card Length	Up to 400mm
Power Supply	Not included
Motherboard Compatibility	EATX(<300mm) ATX, Micro-ATX, Mini-ITX
Expansion	
External 5.25" Drive Bays	0
Internal 2.5" Drive Bays	Up to 2
Internal 3.5" Drive Bays	Up to 2
Expansion Slots	7
I/O Ports	Power button, Reset button, HD Audio, USB 3.0 x 2, Type-C
Physical Specifications	
Dimensions (HxWxD)	475 x 356 x 455 mm / 18.7 x 14 x 17.9 inches
Weight	13.3kg / 29.3 lbs
Features	
Addressable RGB Light	All addressable RGB light devices controlled by motherboard.
Available Fan Port	2x120mm fan ports in the front (2x120mm LFO-4312D ARGB fan included) 3x120mm fan ports on the side 2x120mm fan port in the rear (2x120mm LFO-4312D ARGB fan included)
Water Cooling	Supports radiators up to 360 mm on the side
Power Supply Support	Bottom mounted ATX power supply

※PWM Fan:The model comes with PWM fans and will run at top speed unless connected to a motherboard or controller.

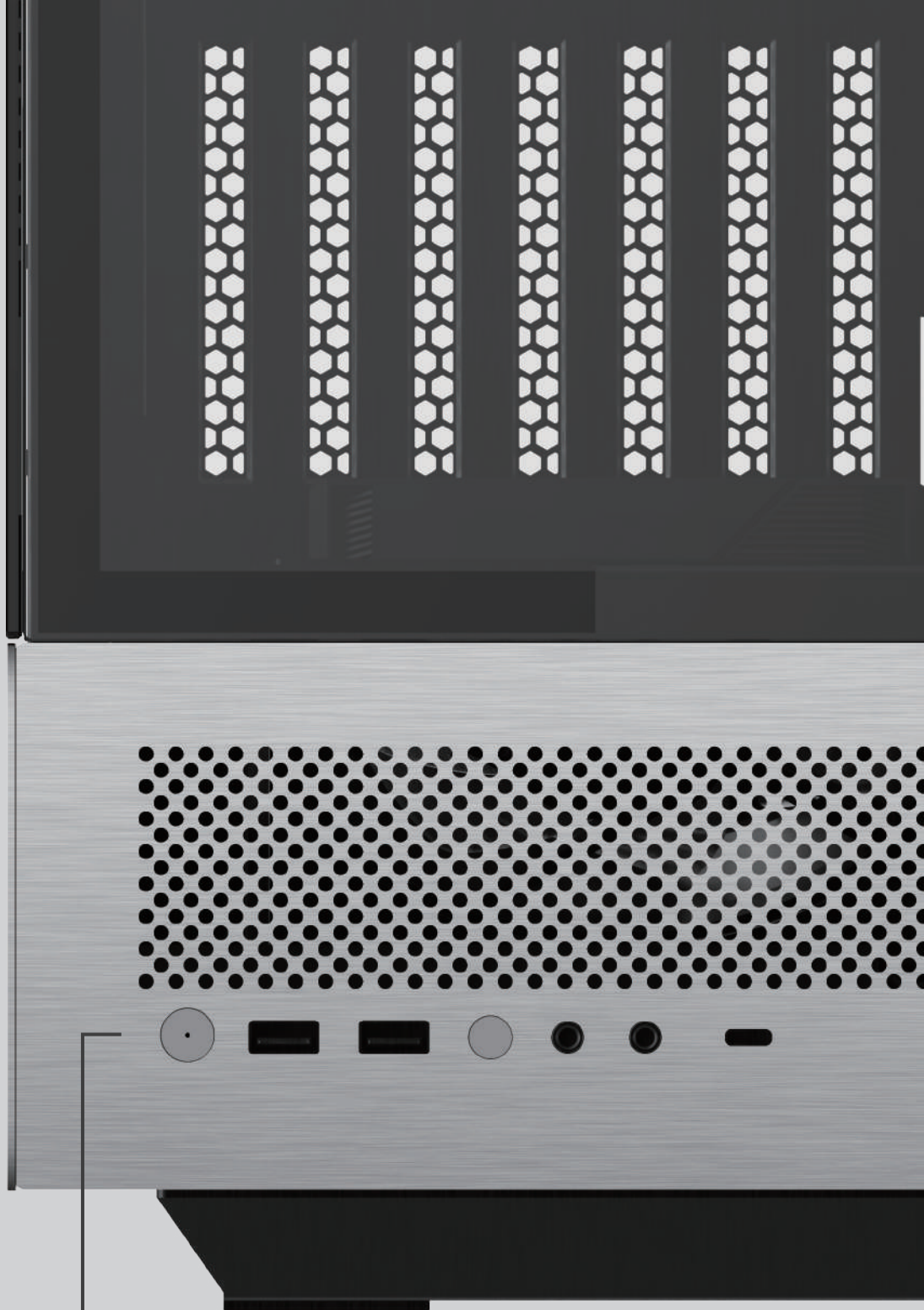

## Front I/O

USB3.0\*2 / Reset / Audio / Mic / Type C

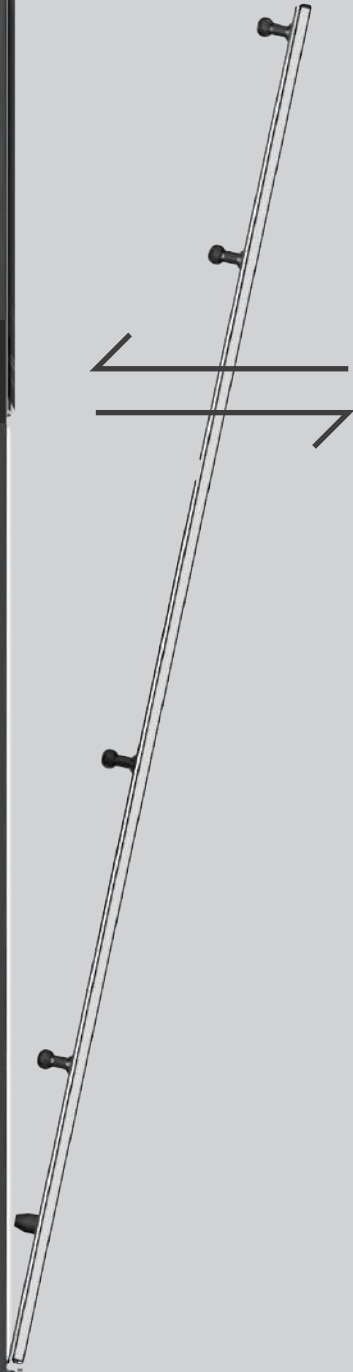

## Glass Panel Installation

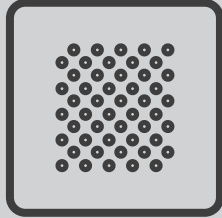

## Mesh Panel Installation

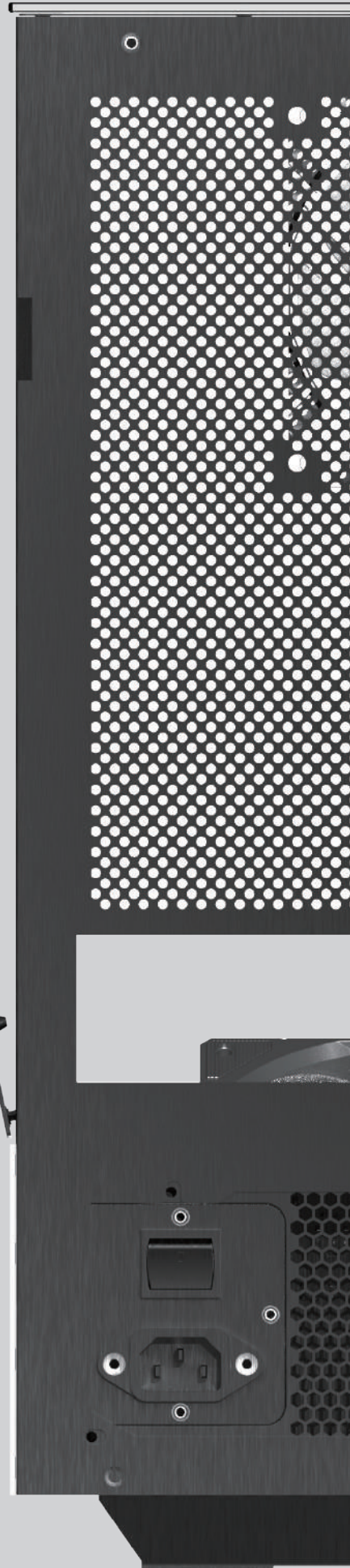



# Top and Front Panel Removal

Reach in and push from the inside out to remove the panel.

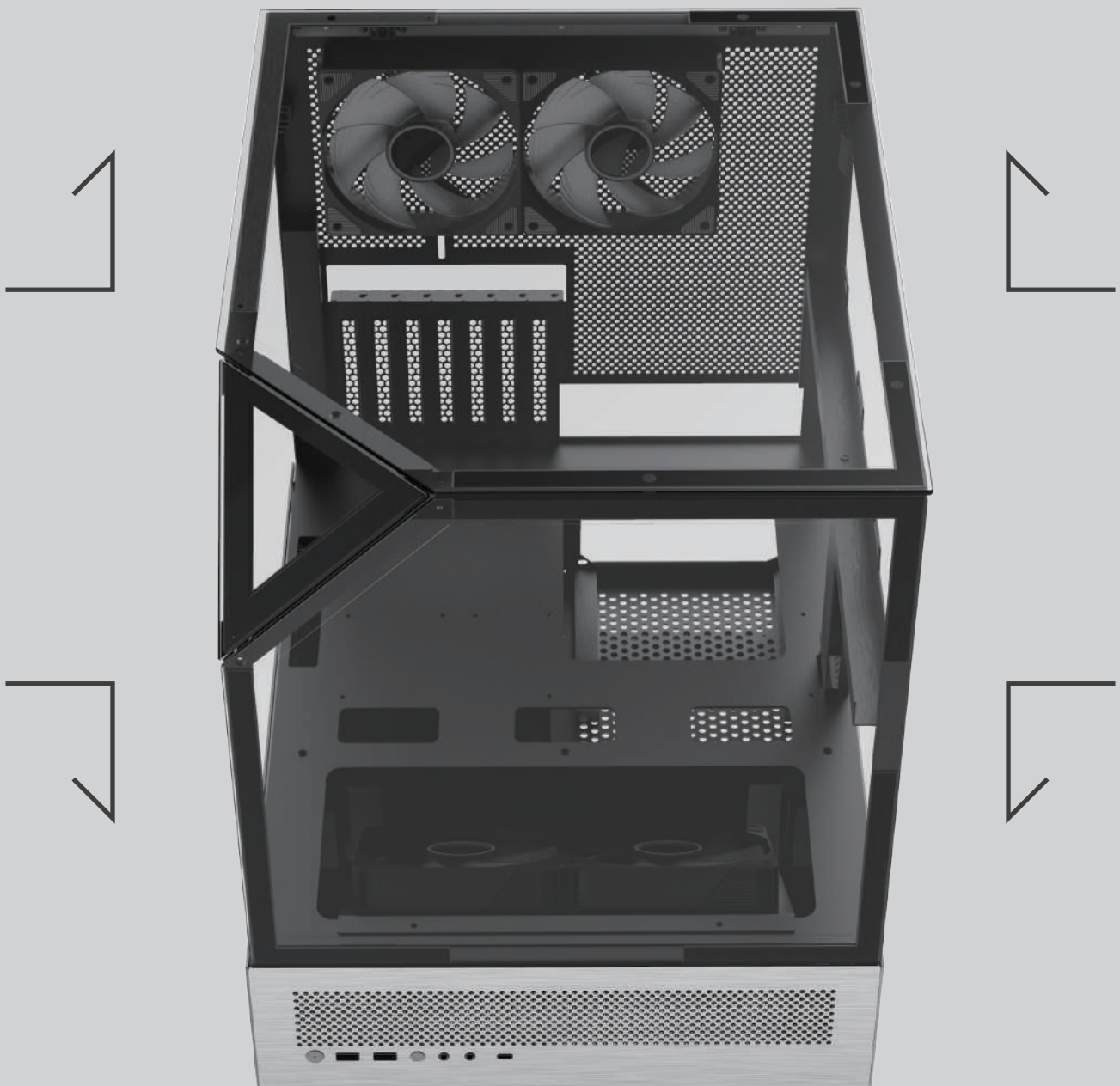



# Metal Panel Removal

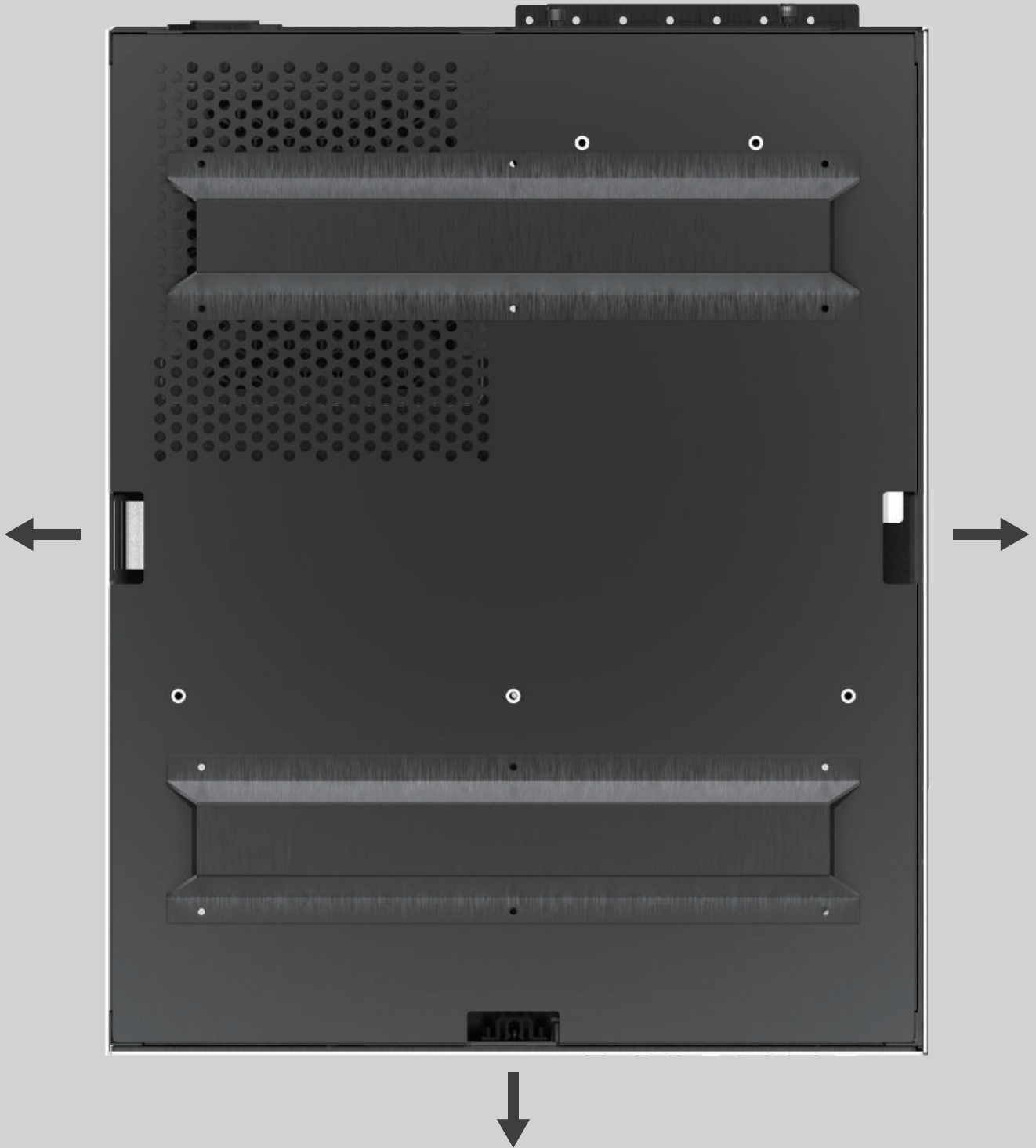

- Bottom View -



## Fans Installation

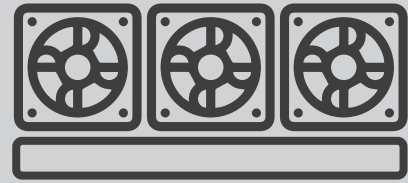
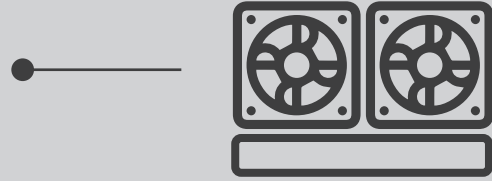
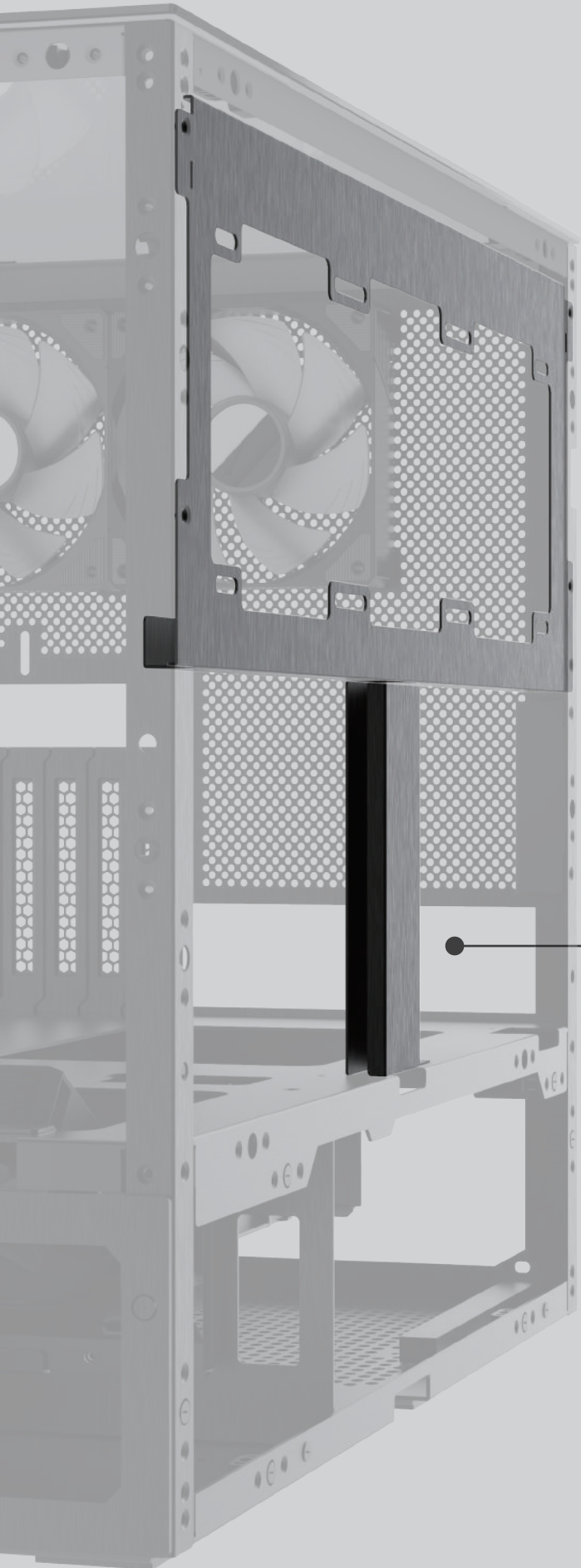

Supports up to  
240 mm or 360 mm fans



Easy to cable management





# MB Support

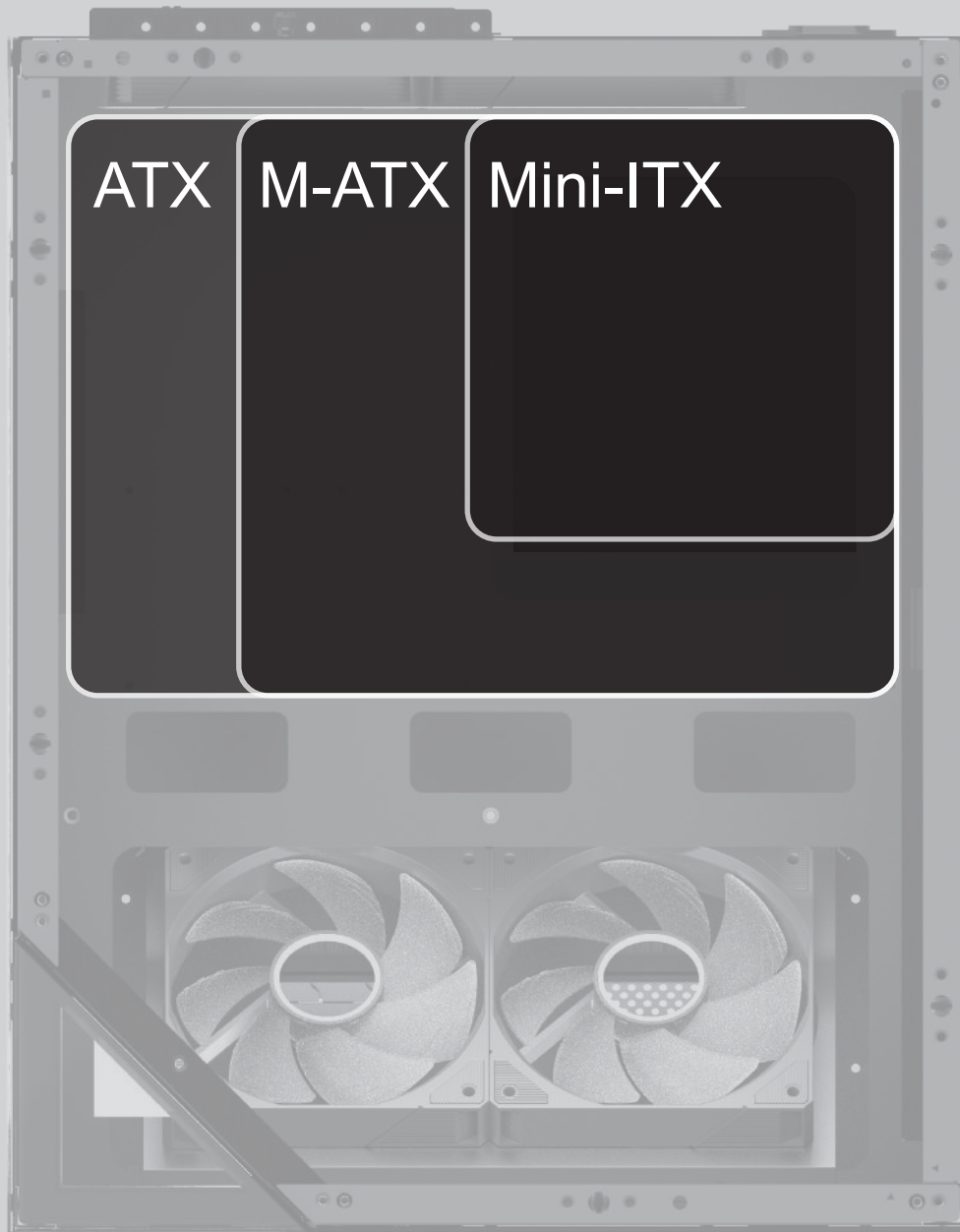



# PCI-e Installation

Step1

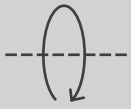

Step2

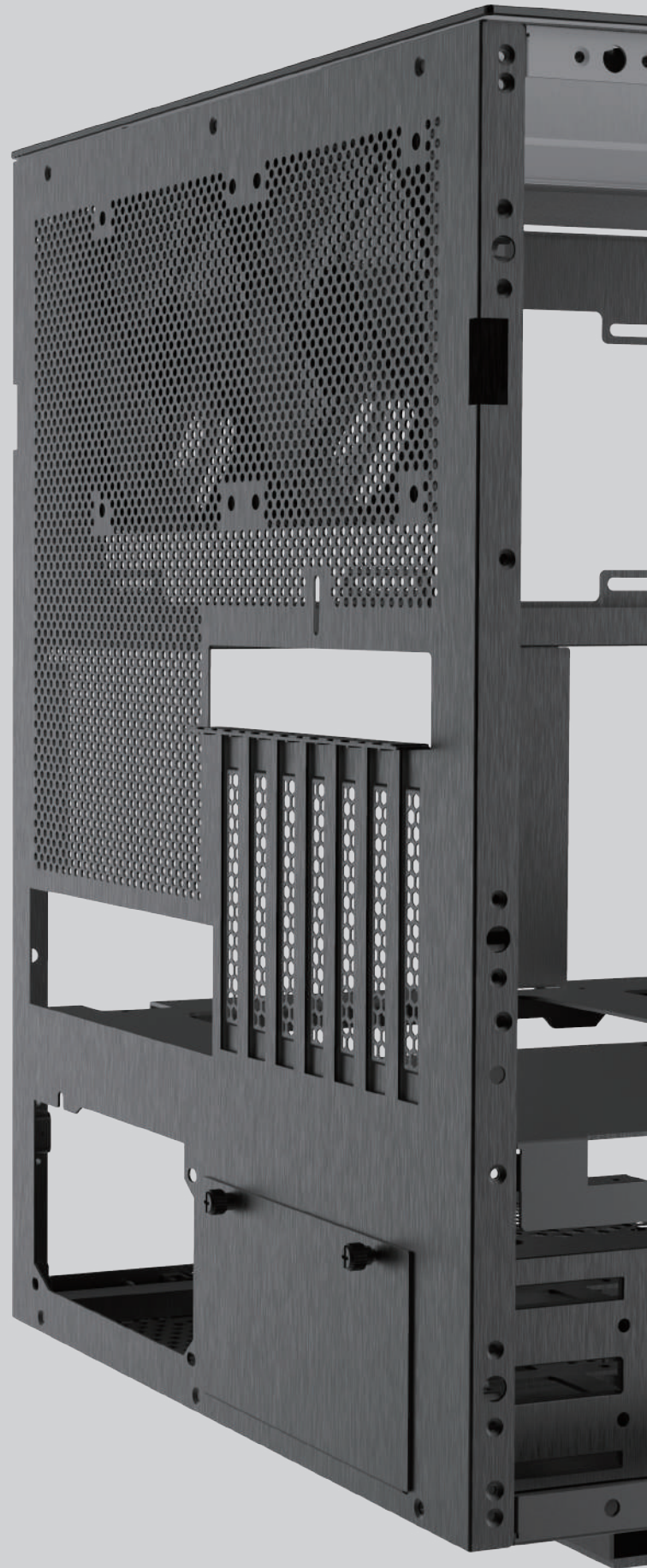



# GPU Support

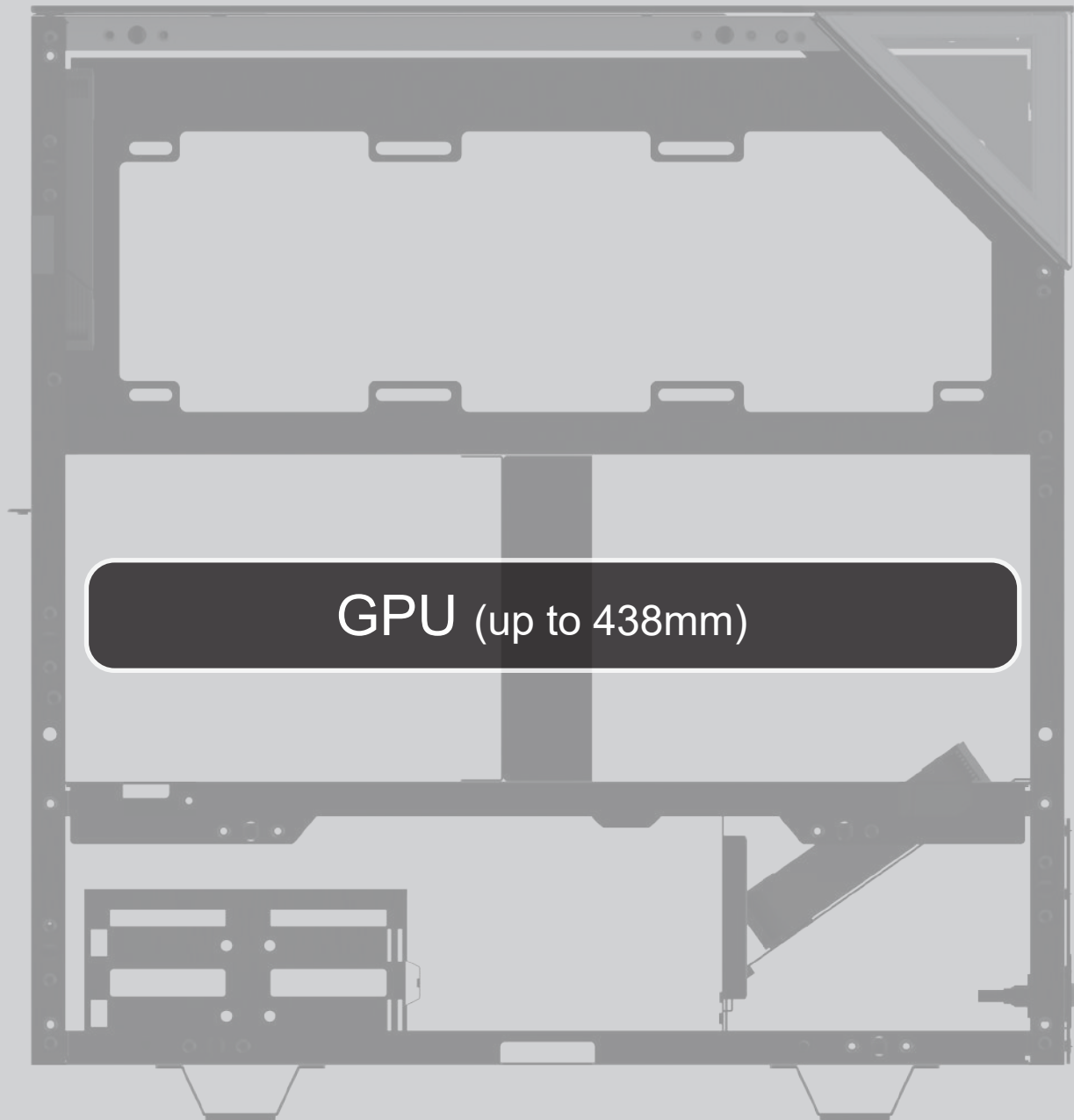



# Storage Drive Installation

Supports to  
2 x 3.5" HDD or 2x 2.5" SSD



HDD

x2



SSD

x2

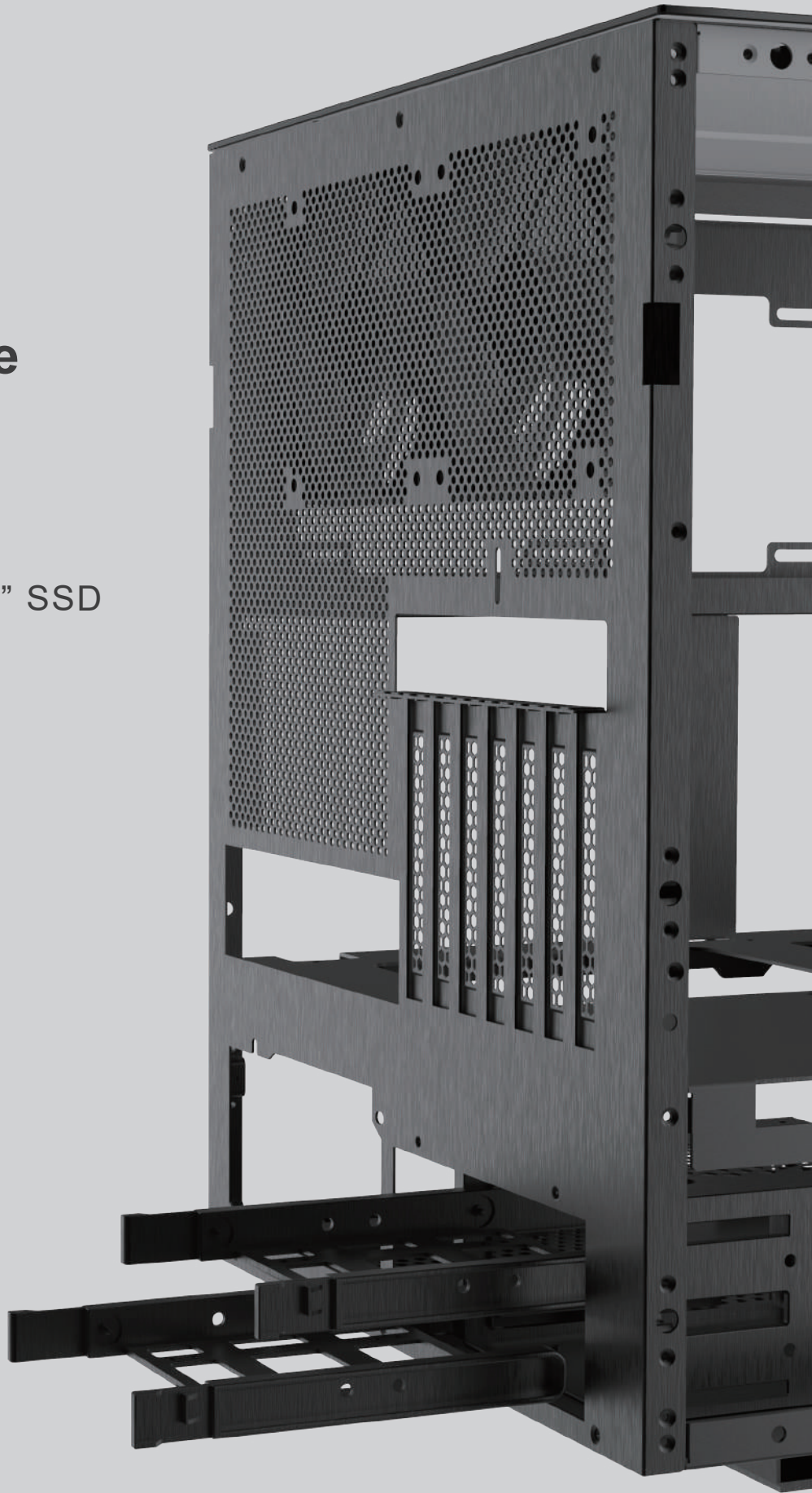

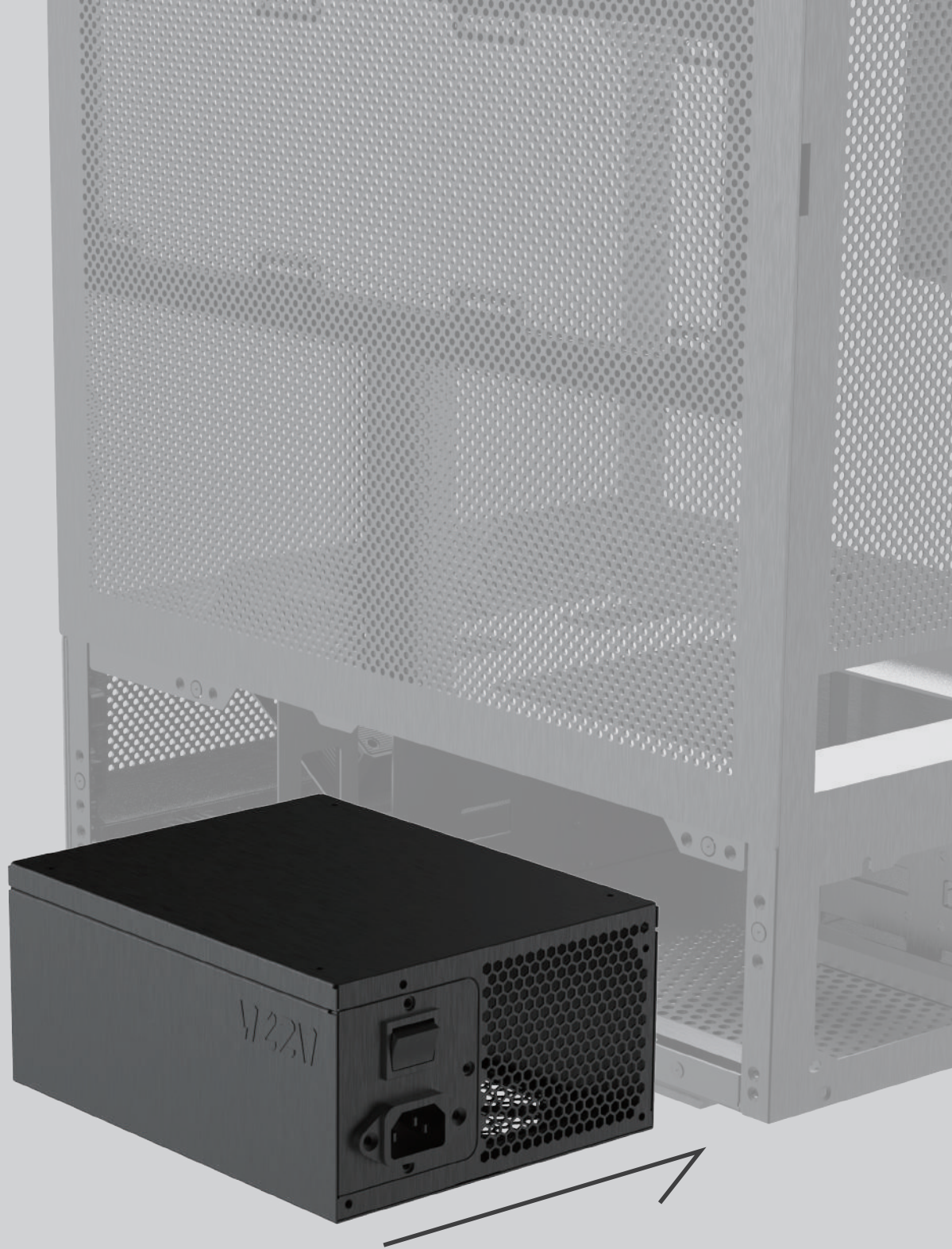

## Power Installation

Mounted from the side, with the fan facing down

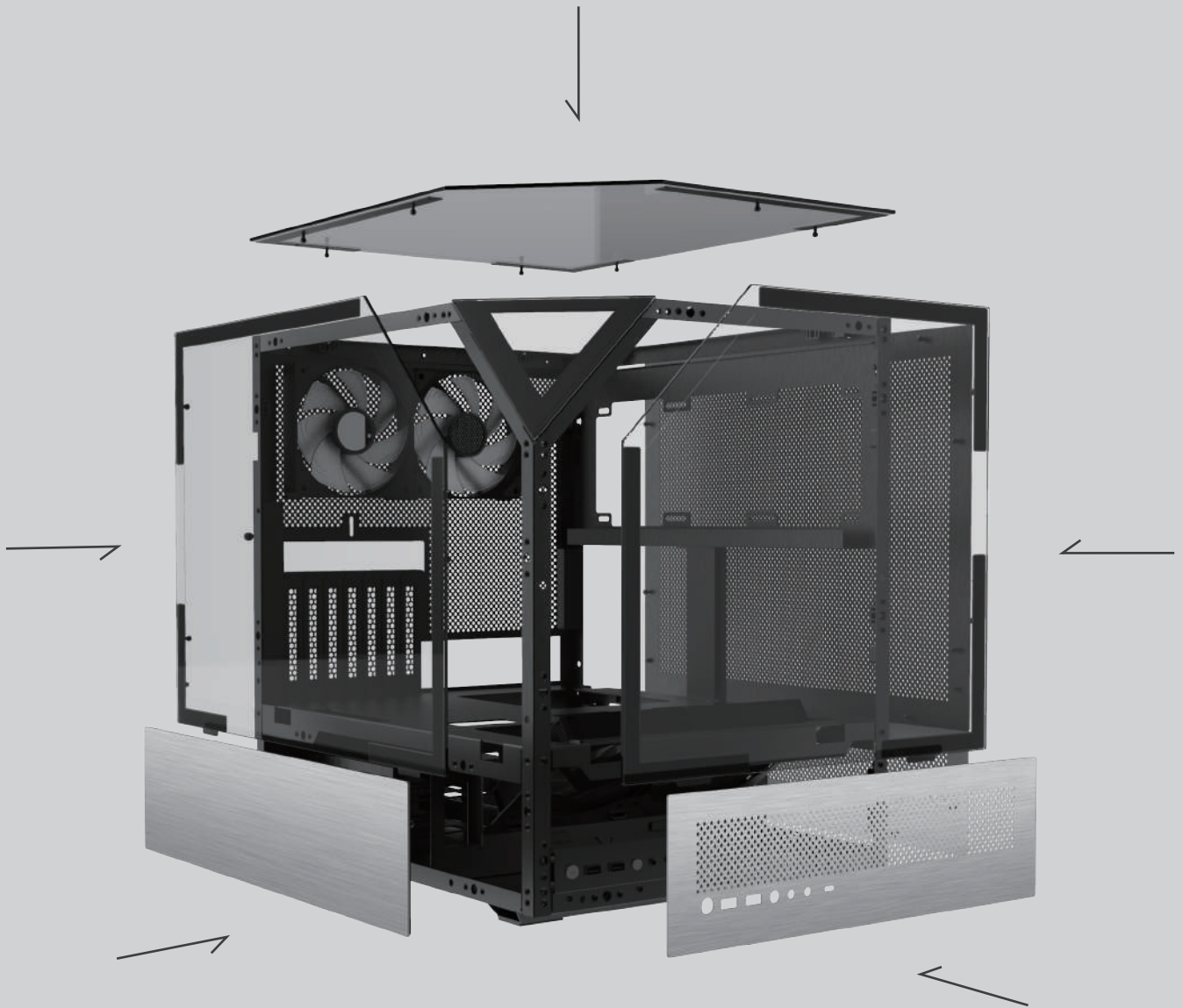

## Panel Installation

